



VECTOR LED

Illuminate to communicate

Choose a profile

The **Vector LED** range has several variations of aluminium frame profiles to fit perfectly with any setting. Wall-mounted, free-standing single or double-sided graphics, the helpful guide below shows all options to choose from.



Custom and standard sizes available



Each section can be cut into smaller sections for ease of transport. A straight connector is required in addition to the 90° angle connectors.



Easy installation using a supplied Allen key



Contact our Design Team who will estimate your project within 48 hours.

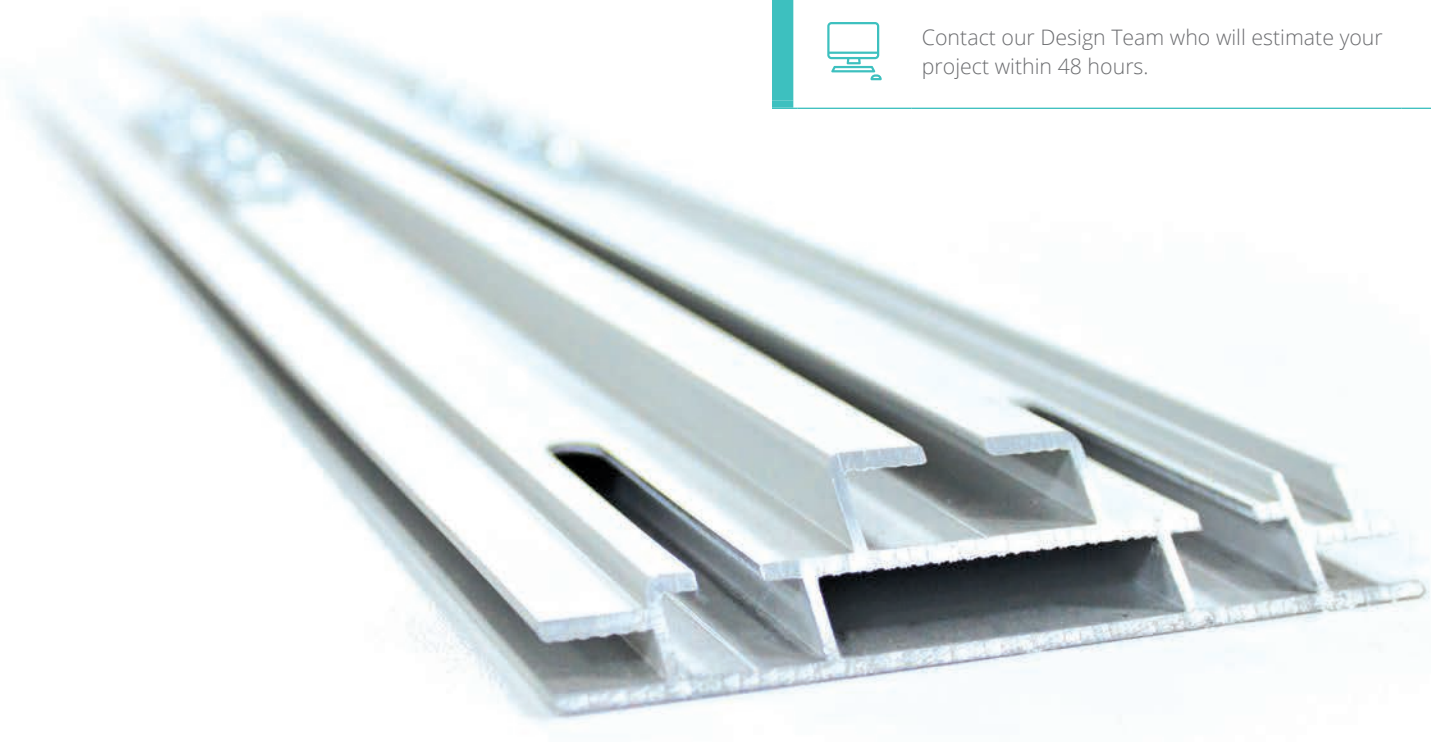

Code	Profile	Wall Mounted	Free-standing	Double-sided
VLB75-CUSTOM	75mm LED	x		
VLB100-CUSTOM	100mm LED		x	x
VLB125-CUSTOM	125mm LED		x	x
VLB150-CUSTOM	150mm LED		x	x

Communication by illumination

Because projects evolve, the aluminium **Vector LED** range, with stretched graphic, lends itself perfectly to an array of different environments, and is one of the simplest communication solutions on the market.

Whether wall-mounted or free-standing, **Vector LED** has a solution for every need and budget. Its wide range offers incredible visual impact to suit every environment: [showrooms](#), [retail outlets](#), [receptions](#), [museums](#), [hospitals](#), [airports](#), [arenas](#), [hospitality areas](#), [college campuses](#), [cinemas](#), [restaurants](#), [exhibitions](#), [schools](#), [motorway service stations](#), [shopping centres](#), [car showrooms](#), [pubs](#) and [theatres](#). In fact the list is endless.

Adaptable:

Anodised aluminium profiles to match surroundings available as optional extra.

Easy to assemble:

Lightweight frames with coded installation system, designed for assembly using a single Allen key.

Renewable graphics:

Graphics including grand format sizes can be manufactured quickly for a fresh new look.

Return on investment:

Structures are simple to assemble, install and re-use in a variety of environments wherever needed.

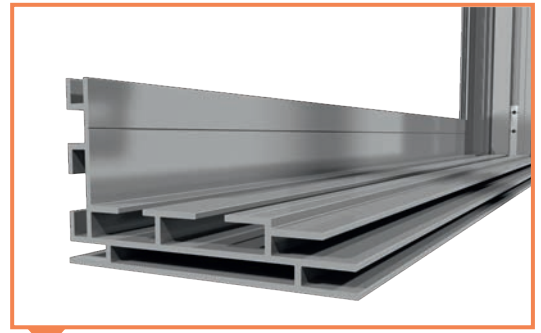

75mm LED

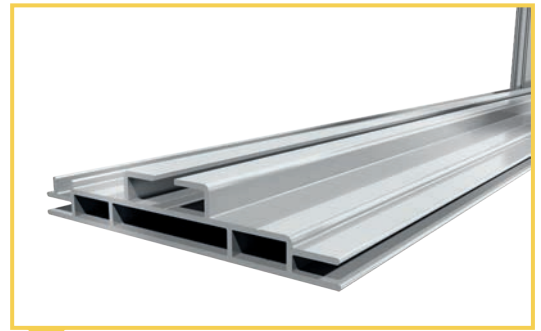

100mm LED

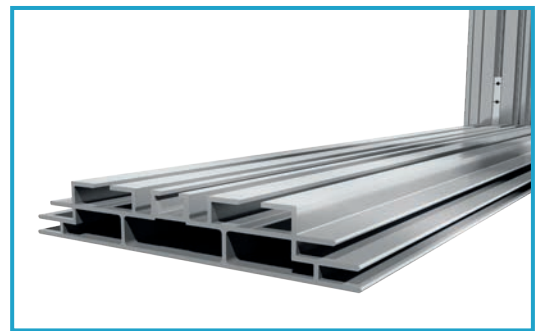

125mm LED



150mm LED



75mm LED

VLB75-CUSTOM / VLB75-2x1 / VLB75-2x2 / VLB75-2x3

Stand out with innovative and bright designs!

- + Available in a range of standard sizes or custom made to order.
- + Creates uniform lighting with no shadows on large frames.
- + Twin extrusions for inserting two visuals of different materials.
- + Sleek, smooth profile for a clean look.
- + Wall mountable only (Not available as a free-standing unit).
- + Linkable LED lighting system, easy to assemble.

Suitable for:

Point of sale displays, showcasing at events, reception areas...

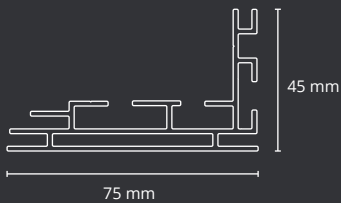

Technical information

- Anodised aluminium 6063 T6
- Weight per ml: 1.143 kg
- Single-sided profile
- Flat rear profile for easy wall fixing
- Reinforcement on the back of the profile to slide a rigid panel if necessary



Accessories

Linkable LED lighting system.
Transformer 24 V.
Stabilising Foot FX295



Suitable for:

Retail environments, banks,
showrooms, museums...

100mm LED

VLB100-CUSTOM / VLB100-2x1 / VLB100-2x2 / VLB100-2x3

Economical light boxes, ideal for large-scale projects.

- + Available in a range of standard sizes or custom formats.
- + Consistent lighting over frame.
- + Economical solution, ideal for small and medium lightboxes.
- + Linkable LED lighting system, easy to assemble and disassemble.
- + Lightweight, free-standing structure.
- + Suitable for single or double-sided use.

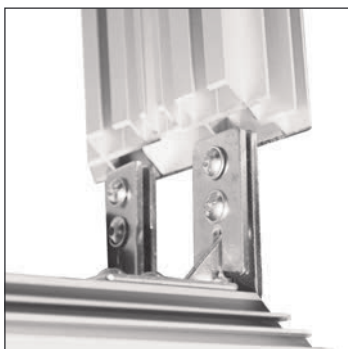
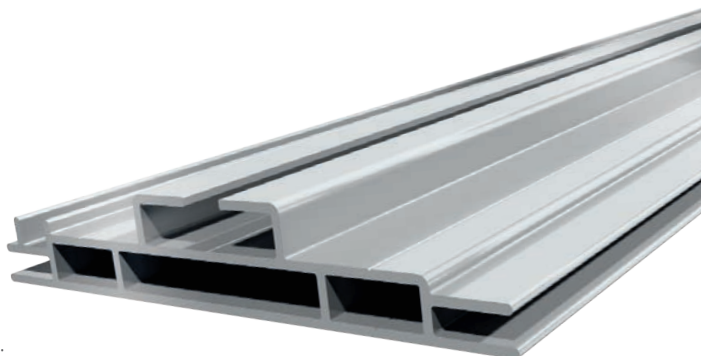

Accessories

Stabilising Foot FX295
Linkable LED lighting system.
Transformer 24 V.

Technical information

- Anodised aluminium 6063 T6
- Weight per ml: 1.082 kg
- Double-sided profile
- SEG graphic panel

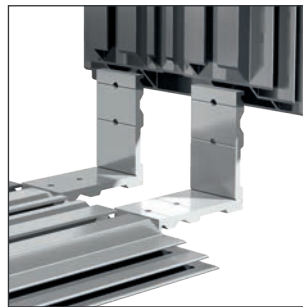
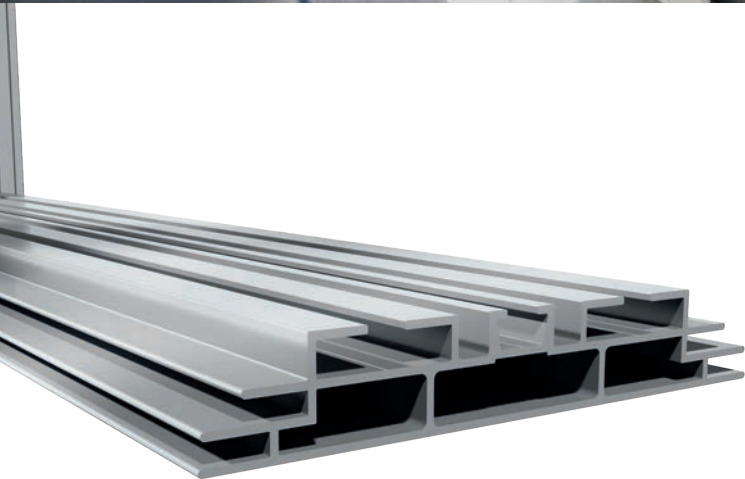

Suitable for:

Shop fitting, cinema lobbys, restaurants, Airports ...

125mm LED

VLB125-CUSTOM / VLB125-2x1 / VLB125-2x2 / VLB125-2x3

A stronger and more robust extrusion for maximum visibility thanks to our exclusive double extrusion profile.

- + Available in a range of standard sizes or custom formats.
- + Consistent, effective lighting - covering the complete frame.
- + Twin extrusions for inserting two visuals of different materials. Ideal solution for larger free-standing frames.
- + Linkable LED lighting system, easy to assemble and disassemble

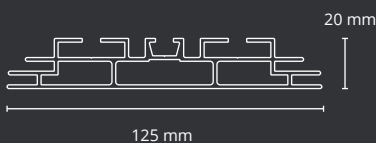

Technical information

- Anodised aluminium 6063 T6
- Weight per ml: 1.645 kg
- Double-sided profile
- SEG graphic panel

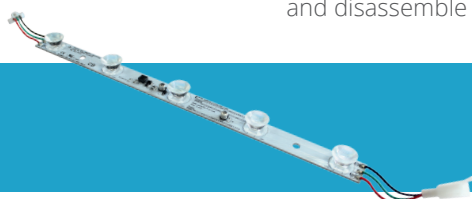

Accessories

Linkable LED lighting system.
Transformer 24 V.
Stabilising Foot FX295

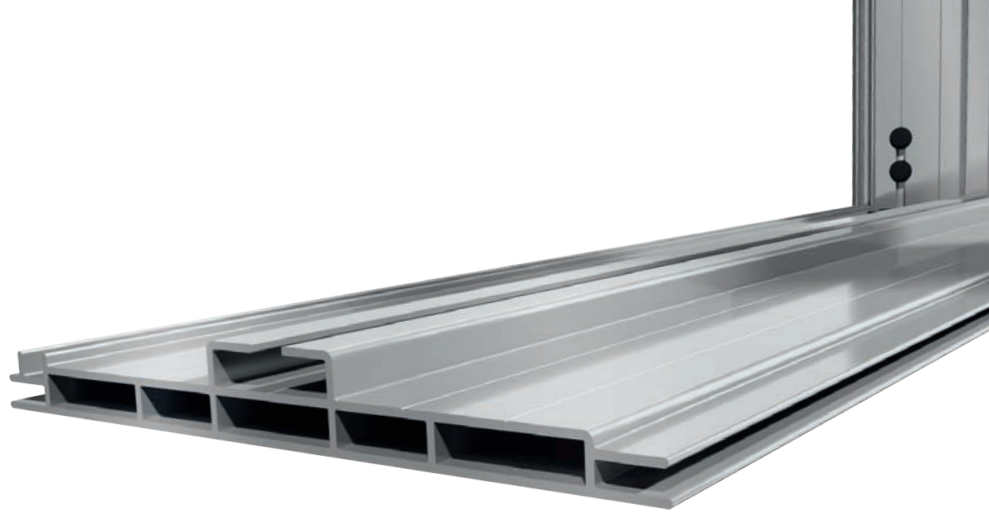

150mm LED

VLB150-CUSTOM / VLB150-2x1 / VLB150-2x2 / VLB150-2x3

Large-scale projects require large format light boxes. They create huge impressions yet are economical to run.

- + Available in a range of standard sizes or custom formats.
- + Consistent bright lighting without any shadowing.
- + Economic solution.
- + LED plug and play lights, easy to assemble and disassemble.
- + Single or double-sided use.
- + Optional rigid panel infill channel.

Suitable for:

Retail and entertainment environments, business reception areas, pedestrian signage...

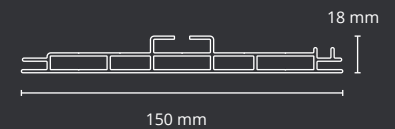

Technical information

- Anodised aluminium 6063 T6
- Weight per ml: 1.542 kg
- Double-sided profile
- SEG graphic panel

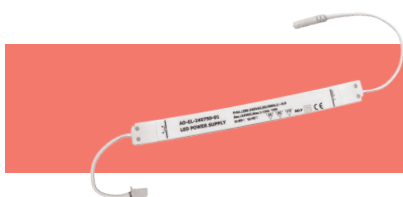

Accessories

Linkable LED lighting system.
Transformer 24 V.
Stabilising Foot FX295

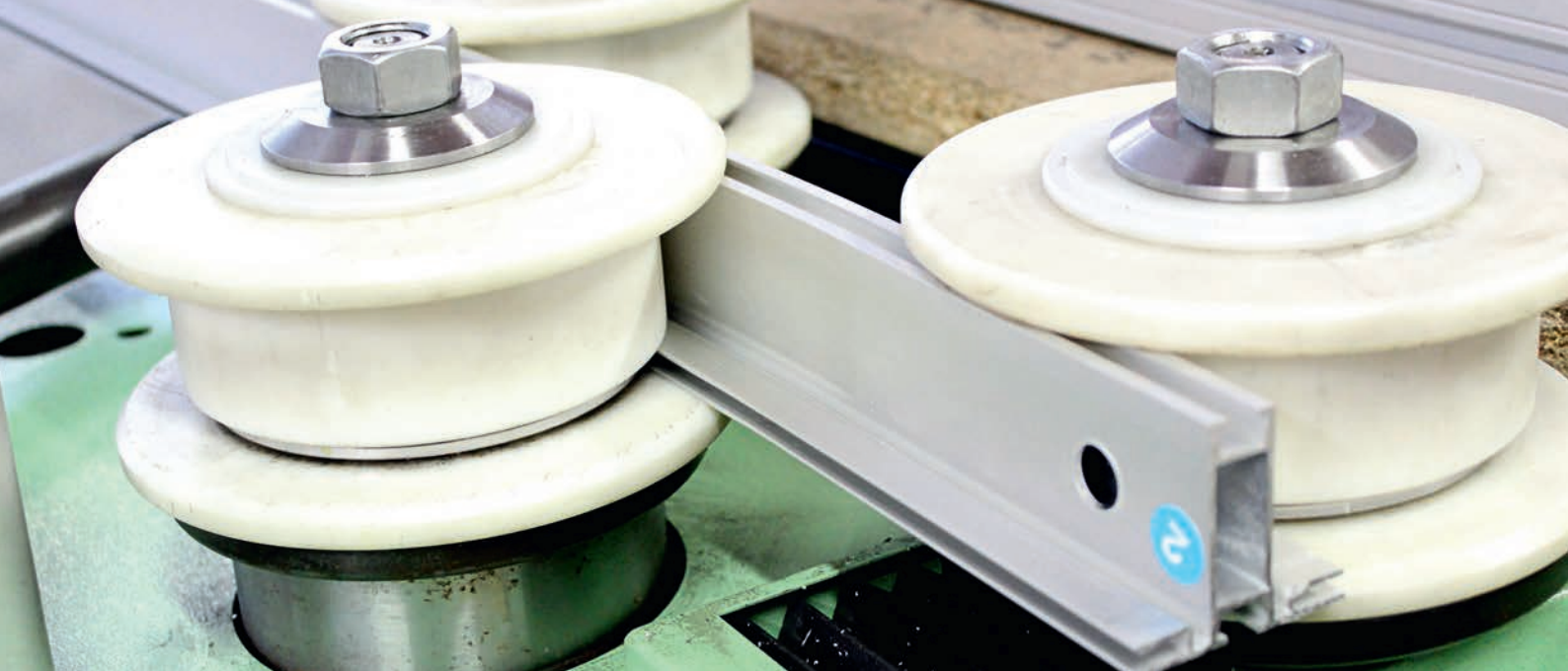

Manufactured in the UK for a high quality end product

Vector LED offers you versatile solutions that adapt to any type of environment.

All stages of design and manufacturing are carried out locally by our own teams at our production facility. This proximity allows you to benefit from the expertise of a partner who manages your project entirely, from its concept to its delivery.

With a wide selection of profiles and configurations, you are sure to find the **Vector LED** solution that will meet your needs. Our CAD department is at your disposal to guide you in choosing and designing the **Vector LED** solution for your installation.



Customised monitoring and management for each project

Our CAD designers are the masters of Vector LED solutions! Request a 3D visual of your free-standing frames or stands to give you an overview of the final result.



Incredibly vibrant print - perfect for Vector LED

We have selected the perfect range of media to create maximum vibrancy with amazing colours and details. These medias, combined with your choice of extrusions and the latest LED technology, create perfect results and brings your brand to life.

All of our lightboxes are made to order in a range of sizes or can be custom manufactured to suit your exact requirements. Their compact lightweight profiles also make them simple to transport and easy to install.

So if you're looking for a vibrant display solution that brings the message to life, the **Vector LED** range will meet your customers expectation and heighten their brand communication.



A silicone edged gasket is sewn directly on the hem of the graphic and is inserted by simply pressing into the extrusion channel of the Vector LED frame.

Once installed the graphic is perfectly adjusted and tensioned to communicate your brand message or display.



VECTOR LED

Illuminate to communicate